



**A TETŐ,
ERŐS MINT A BIKA!**

NAPELEMEK, NAPKOLLEKTOROK SZAKSZERŰ RÖGZÍTÉSE FÉMLEMEZ FEDÉSEKEN

**VII. NAPENERGIA-HASZNOSÍTÁS
AZ ÉPÜLETGÉPÉSZETBEN KONFERENCIA**

2016 március 17.

PREFA HUNGÁRIA KFT. – Nemere Judit



**A TETŐ,
ERŐS MINT A BIKA!**

A PREFA CÉGCSOPORT

- Alapítás éve: 1946
- Cégek központ, gyártás: Marktl/Lilienfeld, Ausztria
- Európai jelenlét: 21 ország
- Magyarországi leányvállalat alapítása: 2004
- Termékek száma > 4000
- Termékcsoportok: tetőfedés, homlokzatburkolat, vízelvezés
- Alapanyag: alumínium ötvözet





A TETŐ,
ERŐS MINT A BIKA!

CLASSIC



ZSINDELY



ROMBUSZ

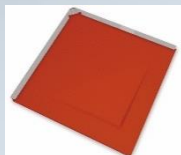

PREFA FEDÉSEK

FX.12

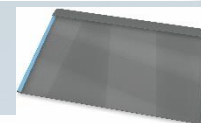
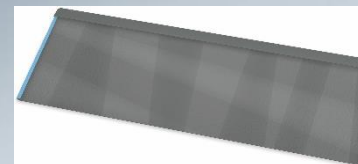

PREFALZ

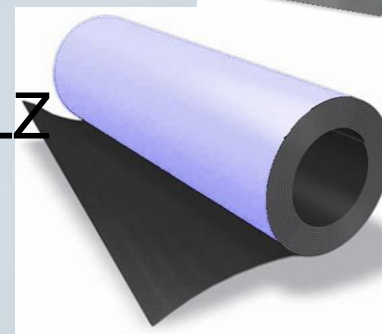



A TETŐ,
ERŐS MINT A BIKA!

SIDINGS

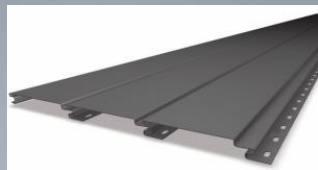

REYNOBO

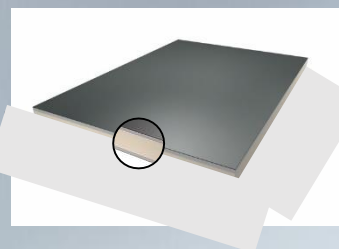

PREFALZ



PREFA HOMLOKZATOK

PROFILHULL
ÁM



FX.12

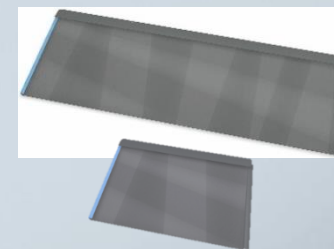

FOGAZOTT
PROFIL

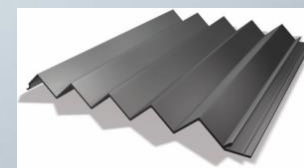



PREFA

**A TETŐ,
ERŐS MINT A BIKAI!**

PREFA VÍZELVEZETÉSEK

1	2	3	4
RINNEKESSEL	SCHRÄGSTÜTZEN	LAUBFÄNGER	RINNEVORKOPF
5	6	7	8
RINNEWINKEL 90°	ALU-DACHRINNE	HÄNGERINNE DILA	STANDROHRKAPPE
9	10	11	12
TELESKOPROHRBOGEN	ROHRBOGEN 72°	ROHRBOGEN 40°	SOCKELKNE
13	14	15	16
ROHREINMÜNDUNG	REGENKLAPPE	WASSERSAMMLER	ABLAUFROHR
17	18	19	20
RINNEHAKEN	RINNEHAKEN HOCHKANT	KUGELVORKOPF	ROHRSCHELLE
21	22	23	24
ROHRSCHELLE MIT M10 GEWINDE OHNE DORN	M10 GEWINDEDORN	STANDROHR MIT REINIGUNGSÖFFNUNG	STANDROHR

Das intelligente Dachrinnen-Gesamtsystem von PREFA bietet Ihnen das komplette Aluminium-Rinnenprogramm inklusive Montagezubehör aus einer Hand – und in Ihrer Wunschfarbe! Damit sich alle Teile perfekt in das Gesamtbild Ihres Gebäudes einfügen.



**A TETŐ,
ERŐS MINT A BIKA!**





**A TETŐ,
ERŐS MINT A BIKA!**

PREFA PS.13 NAPELEM-RÖGZÍTŐ RENDSZER

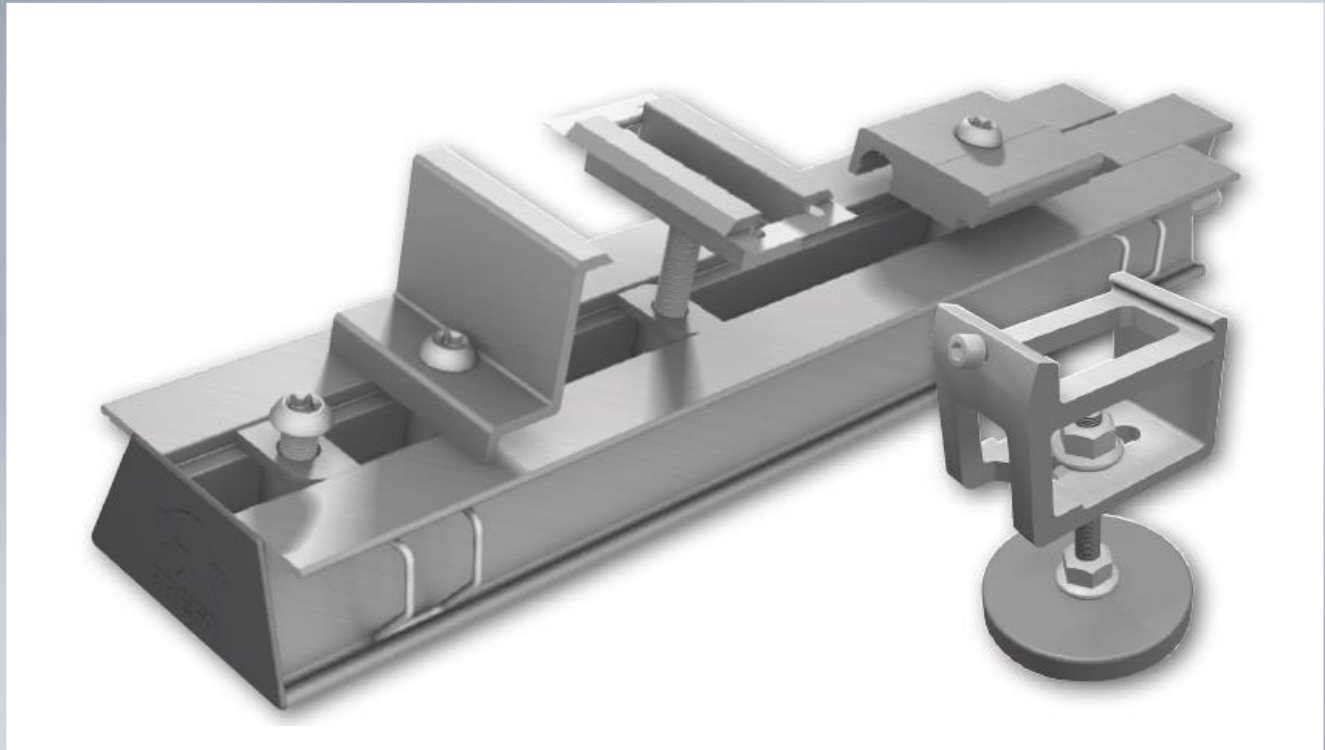

PREFA PS.13 NAPELEM RÖGZÍTÉSI RENDSZER



**A TETŐ,
ERŐS MINT A BIKA!**

- **PREFA Tartó sín**
magas teherbírású, 44X66
- **PREFA Vario-tartó**
PREFA kiselemes fedésekhez
- **PREFA Fix-tartó**
PREFA kiselemes fedésekhez
- **Modulszorító**
A PV modulok gyors és egyszerű rögzítéséhez a tartósínen
(előszerelt egységek rövidítik a szerelési időt)
- **Kábelcsatorna a PREFA kábelrögzítő segítségével**
(tetőformától függően a kábeleknek a sínen történő vezetését teszi lehetővé)
- **PREFA napelem tartó**
kiselemes fedésekhez
- **PREFA Sunny**
korcolt lemezfedéshez

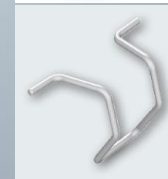
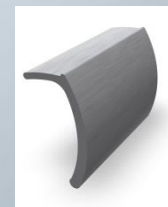
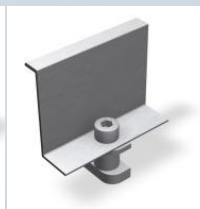

NAPELEMÉK RÖGZÍTÉSE KISELEMES FEDÉSEN



A TETŐ,
ERŐS MINT A BIKA!



PREFA Fix-tartó

el



PREFA Vario-tartó

NAPELEMEK RÖGZÍTÉSE KISELEMES FEDÉSEN

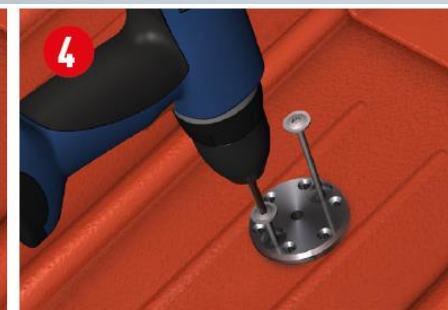
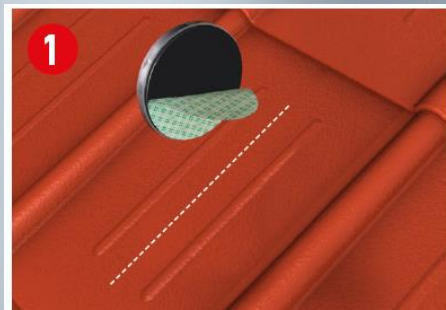



NAPELEMEK RÖGZÍTÉSE KORCOLT FEDÉSEN

A TETŐ,
ERŐS MINT A BIKA

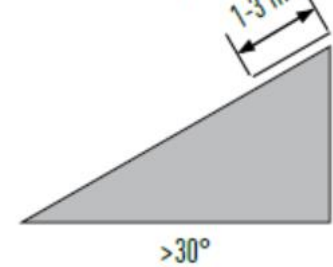
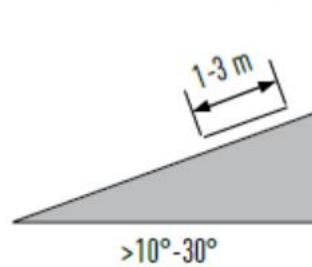
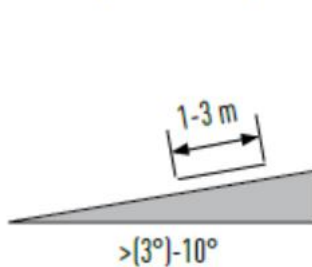
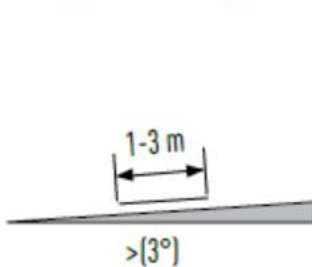
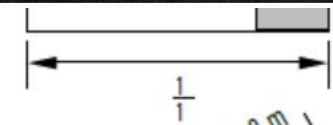
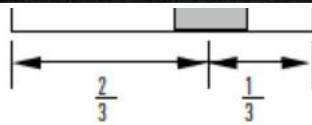
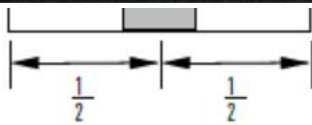
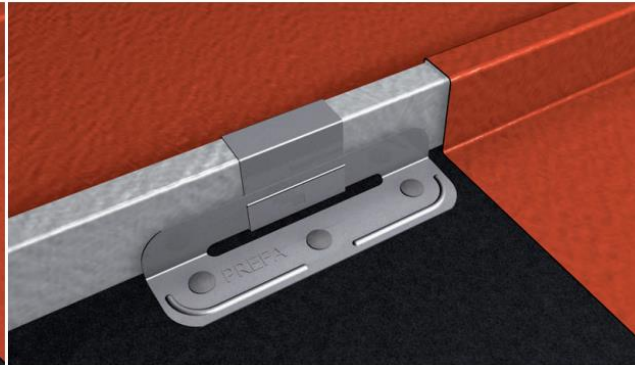
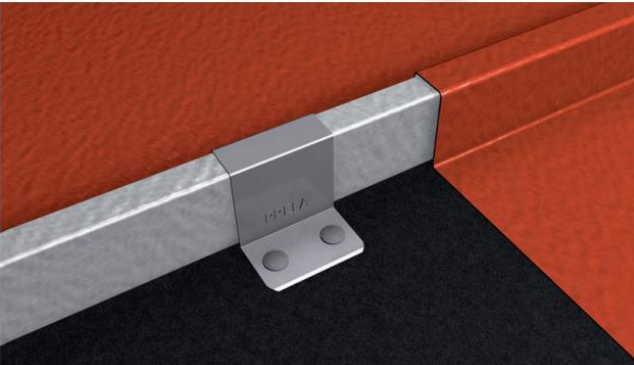
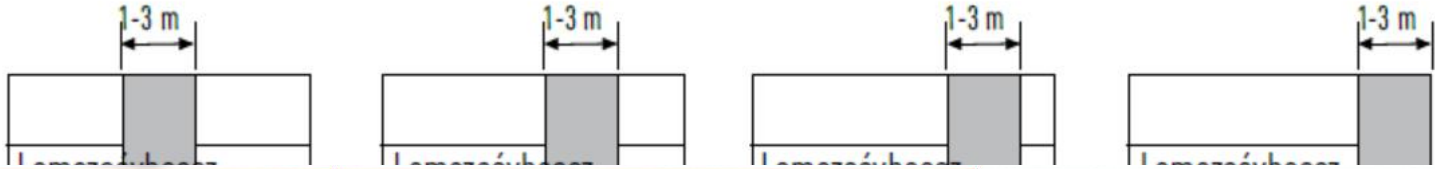



A TETŐ,
ERŐS MINT A BIKA!

NAPELEMEK RÖGZÍTÉSE KORCOLT FEDÉSEN

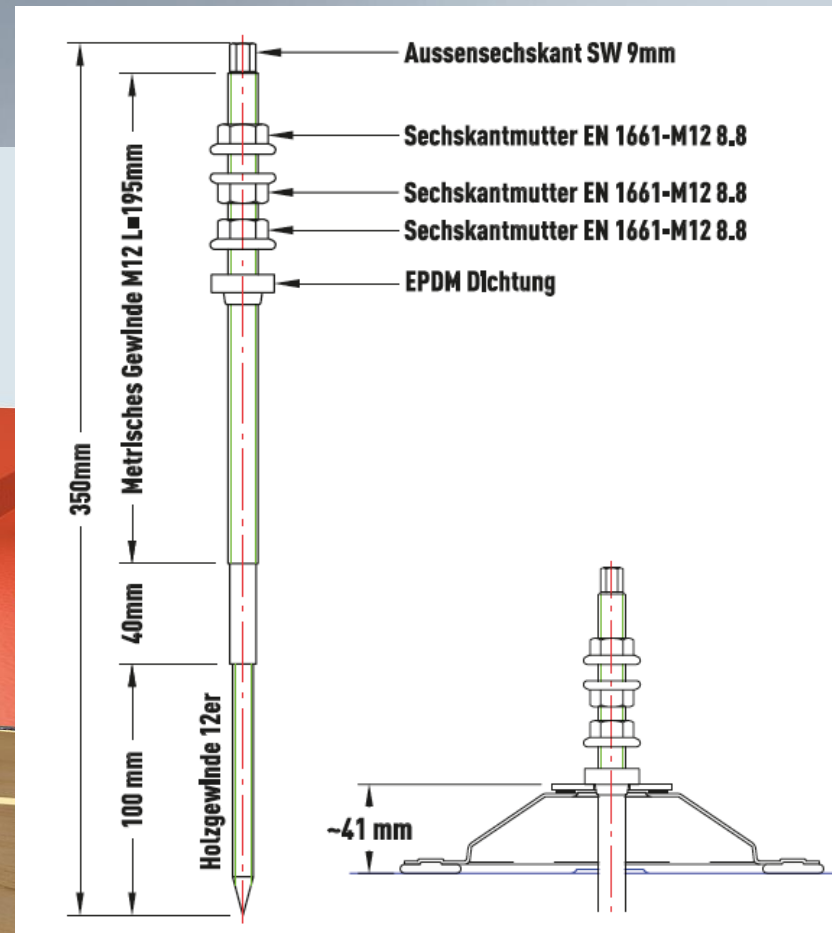



1 Körbejelölés, oválfurat bejelölése

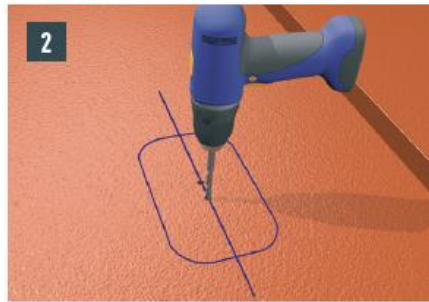

2 Oválfurat körbefúrása a Prefalz lemezsávon

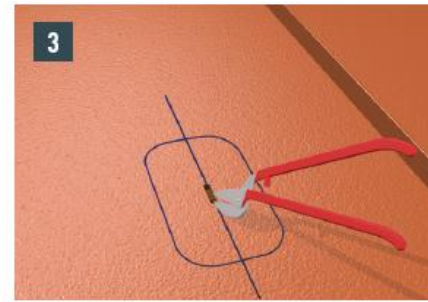

3 Oválfurat kivágása a Prefalz lemezsávból

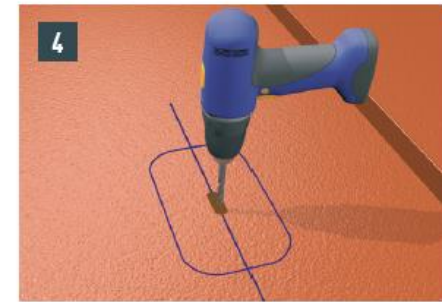

4 Az oválfurat közepén 8mm átmérőjű furat készítése

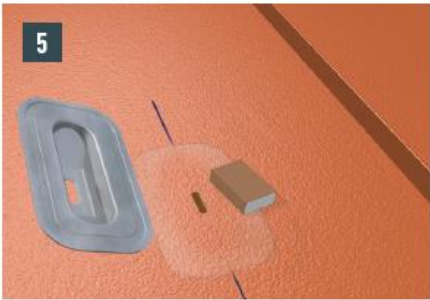

5 A ragasztási sáv megcsi-szolása a felületeken

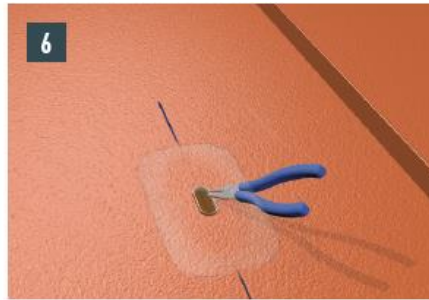

6 Az oválfurat mentén a lemez kiperemezése



7 A felcsiszolt lemezek tisztítása tisztítófolyadékkal



8 10mm Ø ragasztócsík felhordá-sa a tiszta Sunny elemre



9 Sunny elem elhelyezése, leszorítása

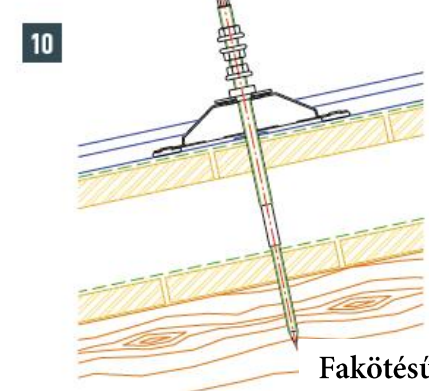

10 Fakötésű csavar behajtása

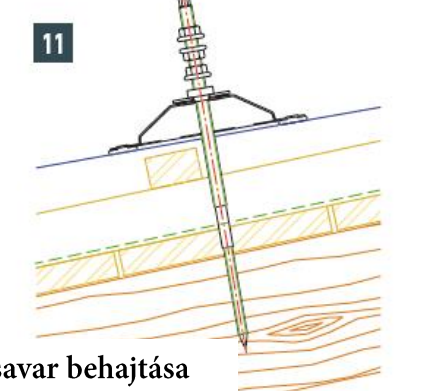

12 Anya meghúzása, ezzel az elem rögzítése



**A TETŐ,
ERŐS MINT A BIKA!**

SZOLGÁLTATÁSOK

- **MŰSZAKI SZAKTANÁCSADÁS**
- **TELJESÍTMÉNYNYILATKOZATOK**
- **ELVÁRT, JAVASOLT JELLEMZŐK**
 - **CSOMÓPONTI MEGOLDÁSOK**
 - **OKTATÁS**
- **EGYEDI MŰSZAKI MEGOLDÁSOK
KIDOLGOZÁSA**

WWW.PREFA.COM



**A TETŐ,
ERŐS MINT A BIKA!**

Köszönöm a figyelmet!